

1-Phase PV Grid-Connected Inverter

Quick Installation Guide

SG7.5RS-L2 / SG8.0RS-L2 / SG10RS-L2



- Contents may be periodically updated or revised due to product development. The information in this guide is subject to change without notice. In no case shall this guide substitute for the user manual or related notes on the device.
- Make sure to read over, fully understand and strictly follow the detailed instructions of the user manual and other related regulations before installing the equipment. The user manual can be downloaded by visiting the website at <http://support.sungrowpower.com/>; or it can be obtained by scanning the QR code on the side of the equipment or the back cover of this guide.
- All installations must be performed by qualified personnel who should have training for installation and commissioning of electrical system, as well as dealing with hazards, have knowledge of the manual and of the local regulations and directives.
- Before installation, check that the package contents are intact and complete compared to the packing list. Contact SUNGROW or the distributor in case of any damaged or missing components.
- The cable used must be intact and well insulated. Operation personnel must wear proper personal protective equipment (PPE) all the time.
- Any violation could result in personal death or injury or device damage, and will void the warranty.

Safety

The inverter has been designed and tested strictly according to international safety regulations. Read all safety instructions carefully prior to any work and observe them at all times when working on or with the inverter. Incorrect operation or work may cause:

- injury or death to the operator or a third party; or
- damage to the inverter and other properties.

Please follow the safety instructions related to the PV strings and the utility grid.

DANGER

Lethal voltage!

- PV strings will produce electrical power when exposed to sunlight and can cause a lethal voltage and an electric shock.
- Only qualified personnel can perform the wiring of the PV panels.



NOTICE











Danger to life from electric shock due to lethal voltage!

- All electrical connections must be in accordance with local and national standards.
- Only with the permission of the utility grid, the inverter can be connected to the utility grid.

Inverter

The icons on the inverter body are as follows.

 <p>Parameters on the DC side.</p>	 <p>Parameters on the AC on-grid side.</p>
--	---

 <p>Disconnect the inverter from all the external power sources before maintenance!</p>	 <p>Burn danger due to hot surface that may exceed 60 °C.</p>
  <p>Danger to life due to high voltages! Do not touch live parts for 10 minutes after disconnection from the power sources. Only qualified personnel can open and service the inverter.</p>	 <p>Danger to life due to high voltages! Only qualified personnel can open and maintain the inverter.</p>  <p>RCM mark of conformity.</p>
 <p>Read the user manual before maintenance!</p>	 <p>CE mark of conformity. EU/EEA Importer.</p>
 <p>Do not dispose of the inverter together with household waste.</p>	 <p>The inverter does not have a transformer.</p>
 <p>Additional grounding point.</p>	

Users may also attach other warning signs as per the requirements of the local standards or installation specifications.

Security Declaration

- For details on the product's network security vulnerability response process and vulnerability disclosure, please scan the QR code on the right or visit the following website:
<https://en.sungrowpower.com/security-vulnerability-management>
- For more information on network security, please refer to the user manual of the communication module or the Data Logger that comes with the product.



DANGER

Danger to life from electric shocks due to live voltage

- Do not open the enclosure at any time. Unauthorized opening will void warranty and warranty claims and in most cases terminate the operating license.
- When the enclosure lid is removed, live components can be touched which can result in death or serious injury due to electric shock.

Lethal danger from electric shock due to possibly damaged inverter

- Only operate the inverter when it is technically faultless and in a safe state.
- Operating a damaged inverter can lead to hazardous situations that can result in death or serious injuries due to electric shock.

WARNING

Risk of inverter damage or personal injury

- Do not connect or disconnect the PV and AC connectors when the inverter is running.
- Wait at least 10 minutes for the internal capacitors to discharge after all electric devices are removed and the inverter is powered off.
- Ensure that there is no voltage or current before connecting or disconnecting the PV and AC connectors.

WARNING

All the warning labels and nameplate on the inverter body:

- must be clearly visible; and
- must not be removed, covered or pasted.

CAUTION

Risk of burns due to hot components!

- Do not touch any hot parts (such as the heat sinks) during operation. Only the DC switch and the LCD panel can safely be touched at any time.

NOTICE

Only qualified personnel can perform the country setting. Unauthorized alteration may cause a breach of the type-certificate marking.

Risk of inverter damage due to electrostatic discharge (ESD)!

By touching the electronic components, you may damage the inverter. For inverter handling, be sure to:

- avoid any unnecessary touching; and
- wear a grounding wristband before touching any connectors.

- O conteúdo pode ser periodicamente atualizado ou revisado devido ao desenvolvimento de produtos. As informações contidas neste guia estão sujeitas a alterações sem aviso prévio. Sob nenhuma circunstância este guia deve substituir o manual do usuário ou avisos relacionados no dispositivo.
- Certifique-se de ler, entender e seguir rigorosamente as informações detalhadas no manual do usuário e outras regulamentações anteriores antes de instalar o equipamento. O manual do usuário pode ser baixado no site <http://support.sungrowpower.com/>, ou pode ser obtido por meio da leitura do código QR na lateral do equipamento ou na contracapa deste guia.
- Todas as instalações devem ser realizadas por pessoal qualificado, que deve ser treinado em como instalar e comissionar o sistema elétrico, e também em como lidar com perigos, ter conhecimento do manual e das normas e diretivas locais.
- Antes de instalar, verifique se o conteúdo da embalagem está intacto e completo na lista da embalagem. Entre em contato com a SUNGROW ou com o distribuidor em caso de componentes danificados ou faltando.
- O cabo utilizado deve estar intacto e bem isolado. O pessoal da operação deve usar equipamento de proteção individual (EPI) o tempo todo.
- Qualquer violação pode causar ferimentos, morte ou danos ao dispositivo e anulará a garantia.

Segurança

O inversor foi projetado e testado em estrita conformidade com as regulamentações internacionais de segurança. Leia todas as instruções de segurança com atenção antes de realizar qualquer trabalho, seguindo-as sempre que manusear o inversor. A operação ou o trabalho incorreto pode causar:

- ferimentos ou mortes ao operador ou a um terceiro;
- danos ao inversor e a outras propriedades.

Siga as instruções de segurança relacionadas às strings FV e à rede de distribuição.

PERIGO

Tensão letal!

- As strings FV produzirão energia elétrica quando expostas à luz do sol, podendo causar tensão fatal e choques elétricos letais.
- Somente funcionários qualificados podem fazer a fiação dos painéis FV.

AVISO

Perigo à vida em decorrência de choques elétricos por tensão letal!

- Todas as conexões elétricas devem estar de acordo com os padrões nacionais e locais.
- O inversor só poderá ser conectado à rede de distribuição com permissão da rede.

Inversor

Os ícones no corpo do inversor são os seguintes.









Parâmetros no lado CC.

CA - Rede



Parâmetros no lado da rede CA.

 <p>Desconecte o inversor de todas as fontes externas de alimentação antes de fazer manutenção!</p>	 <p>Há riscos de queimadura devido à superfície quente que pode exceder os 60 °C.</p>
  <p>A alta tensão traz riscos à vida! Não toque nas partes energizadas durante 10 minutos após desconectá-las das fontes de alimentação. Só funcionários qualificados podem abrir e fazer manutenção no inversor.</p>	 <p>Há riscos de queimaduras devido à superfície quente que pode exceder os 60 °C.</p>  <p>Marca de conformidade CE. Importador da UE/EEE.</p>
 <p>Leia o manual do usuário antes de fazer a manutenção!</p>	 <p>CE mark of conformity. EU/EEA Importer.</p>
 <p>Não descarte o inversor junto com resíduos domésticos.</p>	 <p>O inversor não tem um transformador.</p>
 <p>Ponto de aterramento adicional.</p>	

Os usuários também podem afixar outros sinais de advertência de acordo com os requisitos dos padrões locais ou as especificações da instalação.

Declaração de segurança

- Para obter detalhes sobre o processo de resposta a vulnerabilidades na segurança da rede e sobre a descoberta de vulnerabilidades do produto, escaneie o código QR à direita ou acesse este site:
<https://en.sungrowpower.com/security-vulnerability-management>
- Consulte mais informações sobre a segurança de rede no manual do usuário do módulo de comunicação ou no Data Logger que acompanha o produto.



PERIGO

Perigo à vida em decorrência de choques elétricos por tensão ativa

- Não abra o compartimento em nenhum momento. A abertura não autorizada anulará a garantia e reivindicações de garantia e, na maioria dos casos, rescindir a licença de operação.
- Quando a tampa do compartimento for removida, será possível tocar nos componentes ativos, o que pode causar mortes ou ferimentos graves por choques elétricos.

O choque elétrico decorrente possivelmente do inversor danificado traz perigo letal

- Só opere o inversor quando ele estiver tecnicamente sem defeitos e em um estado seguro.
- Operar um inversor danificado pode causar situações perigosas que resultam em mortes ou ferimentos graves em decorrência dos choques elétricos.

ADVERTÊNCIA

Risco de danos ao inversor ou ferimentos pessoais

- Não conecte nem desconecte os conectores FV e CA quando o inversor estiver funcionando.
- Aguarde pelo menos 10 minutos para que os capacitores internos sejam descarregados depois que todos os dispositivos elétricos forem removidos e o inversor for desligado. Certifique-se de que não haja tensão ou corrente antes de conectar ou desconectar os conectores FV e CA.

ADVERTÊNCIA

No corpo do inversor, todas as etiquetas de advertência e a capacidade anunciada:

- devem estar claramente visíveis; e
- não devem ser removidas, cobertas ou coladas.

CUIDADO

Risco de queimaduras devido aos componentes quentes!

- Não toque nas partes quentes (como os dissipadores de calor) enquanto o dispositivo estiver funcionando. Apenas o interruptor CC e o painel LCD podem ser tocados com segurança a qualquer momento.

AVISO













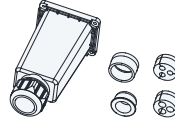

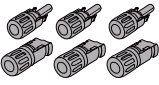
Somente funcionários qualificados podem executar o ajuste de acordo com o país. A alteração não autorizada pode violar a certificação do dispositivo.

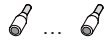
Risco de danos ao inversor devido a descargas eletrostáticas (ESD)!

Se tocar nos componentes eletrônicos, você pode danificar o inversor. Para manuseio do inversor, faça o seguinte:

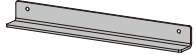
- evite toques desnecessários; e
- use uma pulseira de aterramento antes de tocar em qualquer conector.

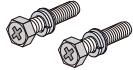
Scope of Delivery / Escopo da entrega

 Inverter	 COM2 connector set	 AC connector set	 WiFi-P2 module
 PV connector (3 pairs)	 Crimp contact (3 pairs)	 European terminal x8	 OT terminal M5x8 x3
 OT terminal M5x14 x3	 Anti-tilt bracket ⁽¹⁾	 Expansion plug set x 2	 Mounting template ⁽²⁾
 Wall-mounting bracket	 Expansion plug set x 2	 Screw M5x12 x 2 ⁽³⁾	 Documents





(1) Optional, separate order and delivery.

(2) For Wall-mounted Installation.

(3) For Wall-Mounted Installation with Mounting Bracket.

- The Scope of Delivery may vary due to model, sales region, or local regulatory requirements. The actual packing list should be referred to for specific configurations.

Mounting location / Local de montagem

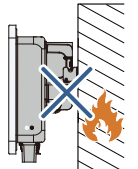
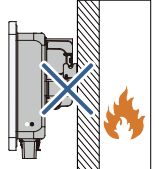
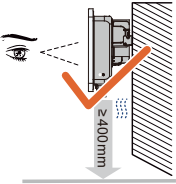
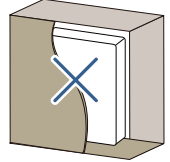

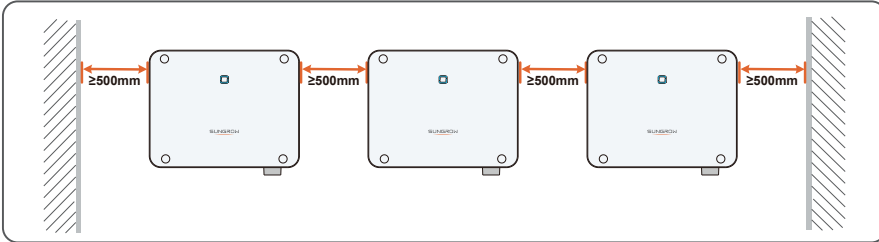
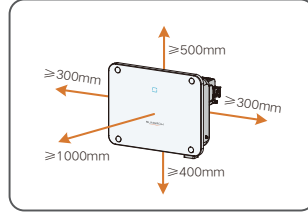
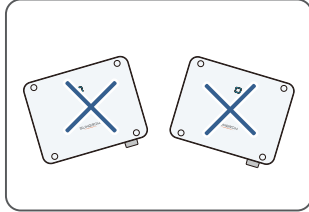
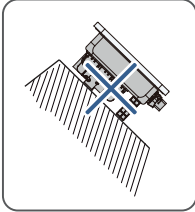
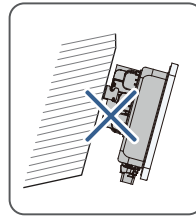
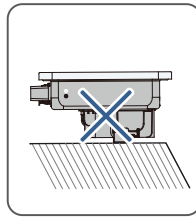
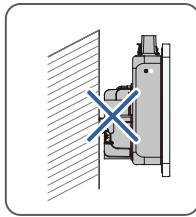
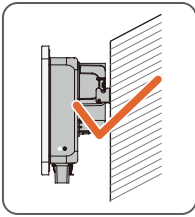
Installation tools / Ferramentas de instalação

Marker



Multimeter: ≥ 600 Vdc

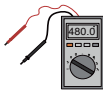

Heat shrink tubing



Measuring tape

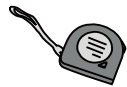

Hydraulic plier



Crimping tool:

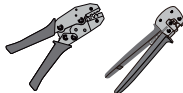

Screwdriver: M4, M5, M6

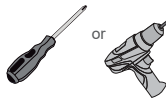

Wrench for MC4 terminal

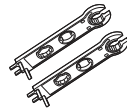

Wire stripper



Hammer drill: $\varnothing 10$



Heat gun

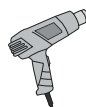

Wrench:
10 mm, 24 mm, 42 mm



Rubber mallet



Allen wrench: H4

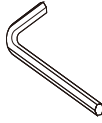

Mounting / Montagem

• Wall-Mounted Installation

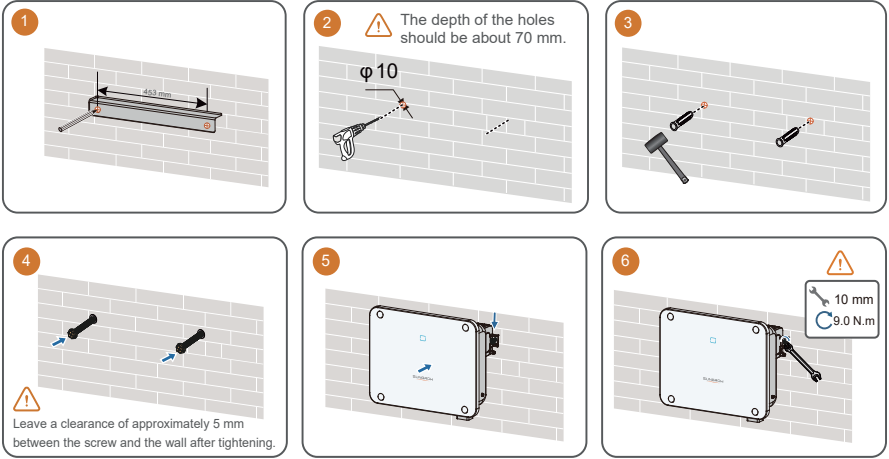

• Wall-Mounted Installation with Mounting Bracket

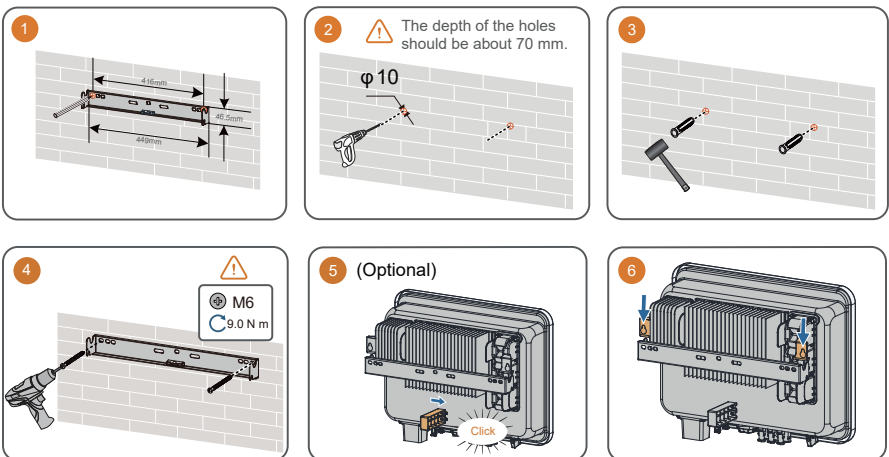

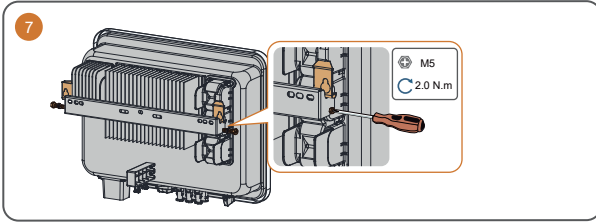

- Use appropriate mounting hardware for wall type.
- The image shown here is for reference only. The actual product received may differ.

PE

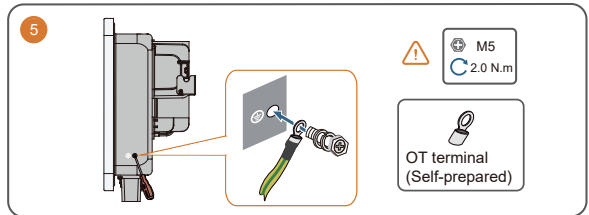
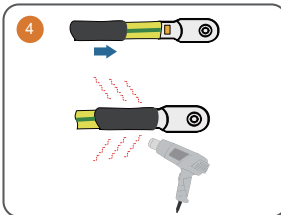
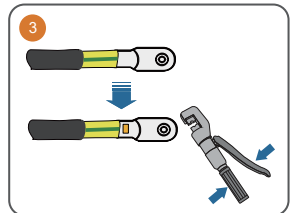
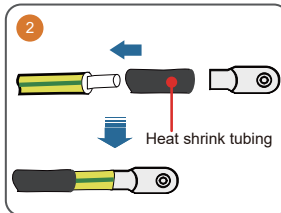
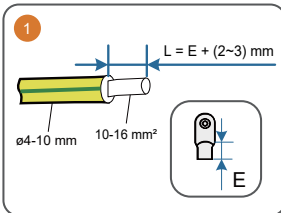

AC

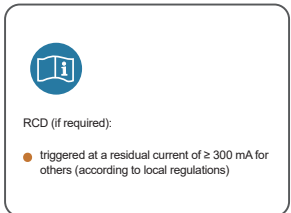
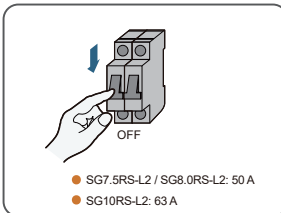
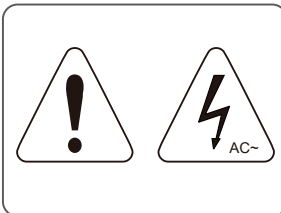

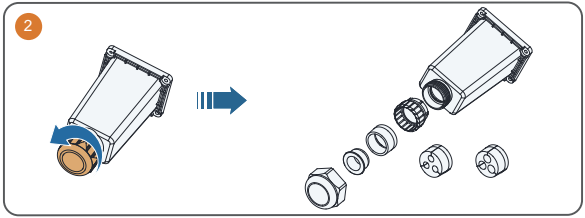
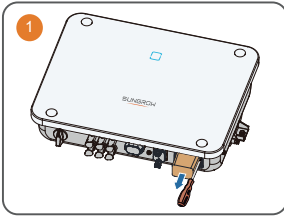

D	Sealing rings	Remarks
16 ~ 18 mm	a+b	One three-core cable
18 ~ 25 mm	a	One three-core cable
6.3 ~ 7.5 mm(*3)	c	8AWG, 7AWG, three single-core cable
7.5 ~ 9.4 mm(*3)	d	6AWG, 5AWG, three single-core cable

Inverter Models	Type	C	D
SG7.5RS-L2 / SG8.0RS-L2	One three-core cable	16 mm - 22mm	10 mm* - 16 mm*
SG10RS-L2	One three-core cable	18 mm - 25mm	10 mm* - 16 mm*
SG7.5RS-L2 / SG8.0RS-L2	Three single-core cables	6.3 mm - 7.5mm	10 mm* - 16 mm*
SG10RS-L2	Three single-core cables	7.5 mm - 9.4mm	10 mm* - 16 mm*

* Select appropriate OT terminals based on the diameter of the AC cable.

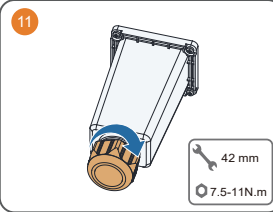
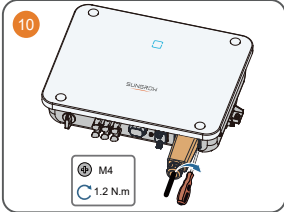
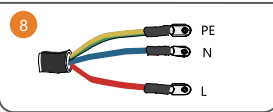
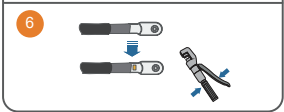
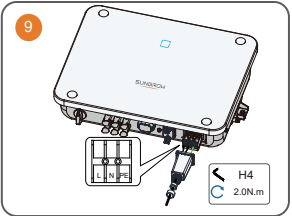
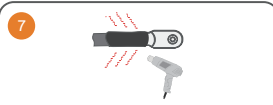
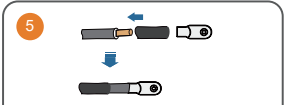

DC

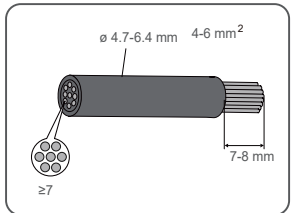
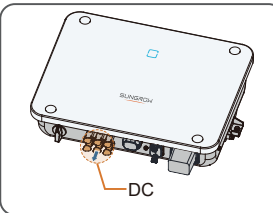
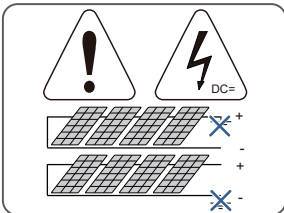

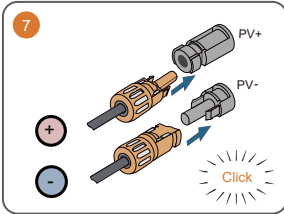
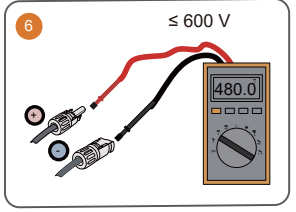
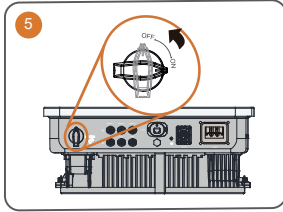
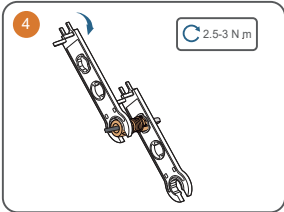
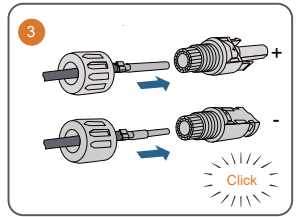
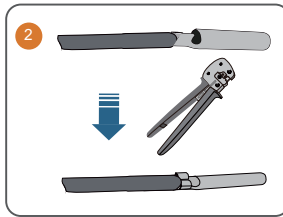
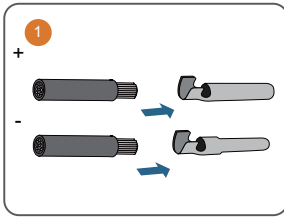

Wireless Communication Module Connection / Conexão do módulo de comunicação sem cabo

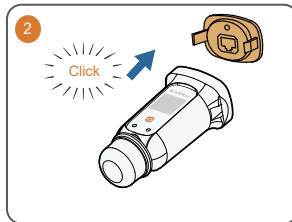
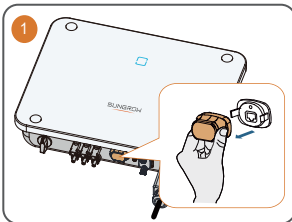

COM2

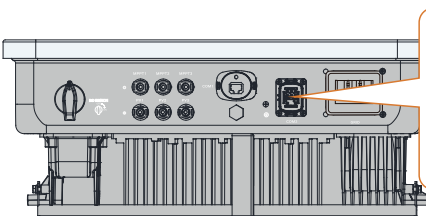

RS485-1	CT	
1	3	5
A	CT+	
2	4	6
B	CT-	
7		8
PE		PE

RS485 Connection / Conexão RS485

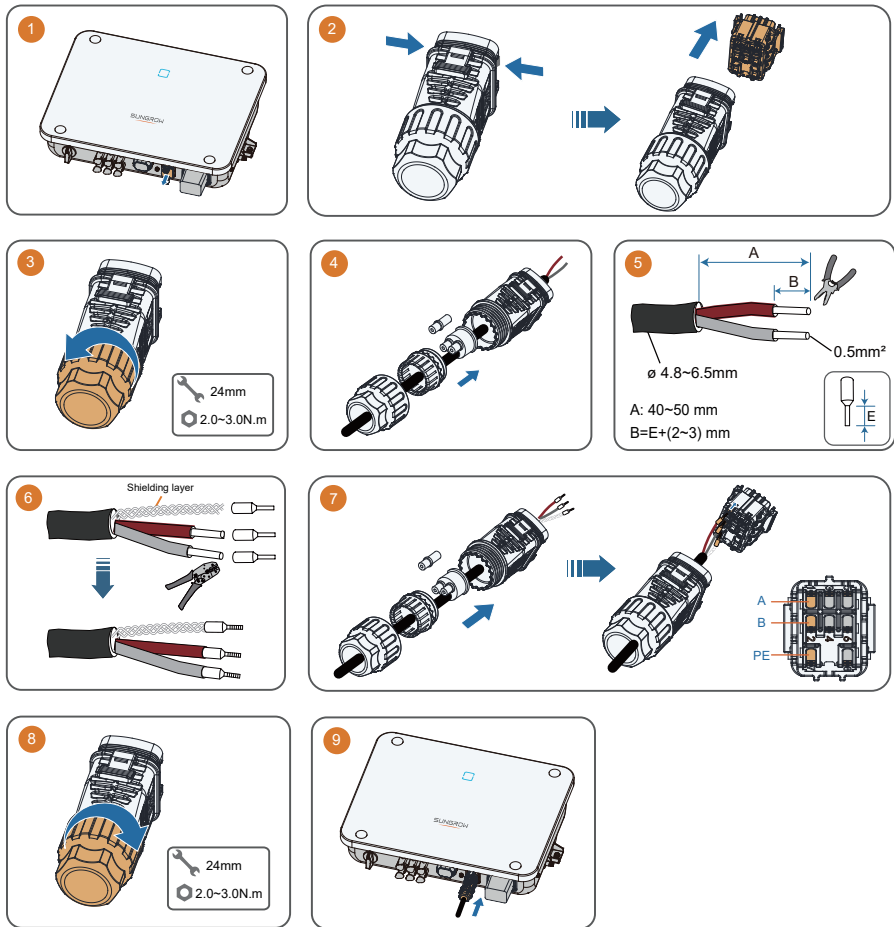

Smart Energy Meter Connection / Conexão do medidor

- For the smart energy meter connection, refer to the steps above for the cable connections on the inverter side. The other end of the communication cable should be connected to the RS485A and RS485B ports of the smart energy meter.
- The S100 meter is not supported in Brazil.

• Connection for S100

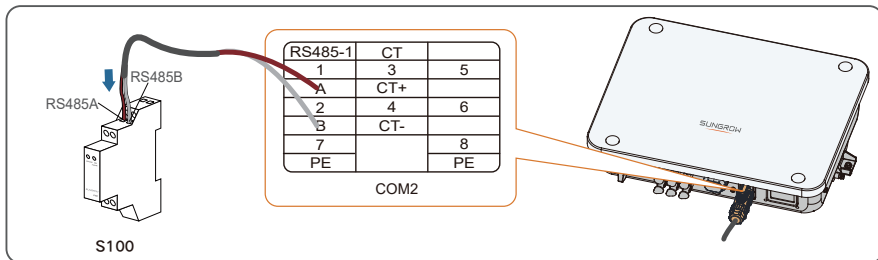

• Connection for DTSU666-20

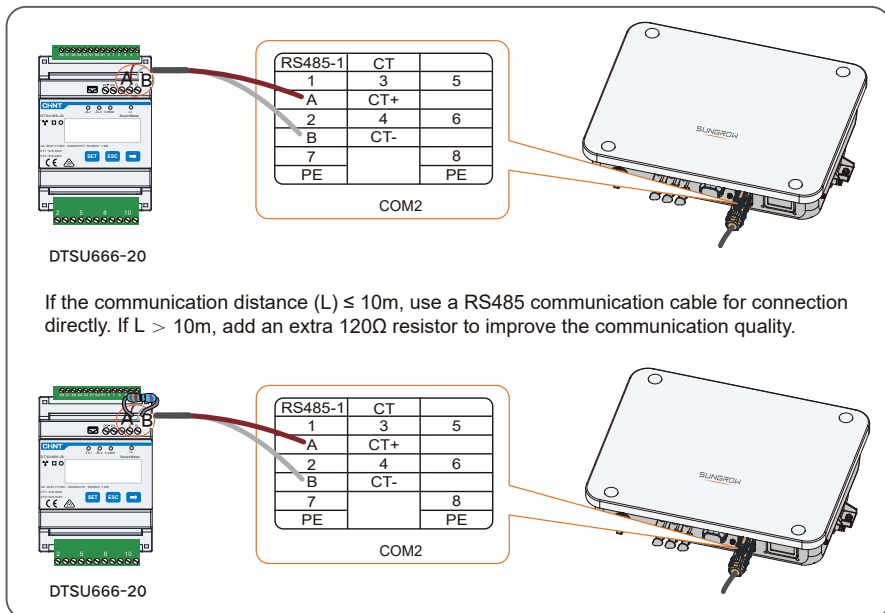

CT Connection / Conexão TC

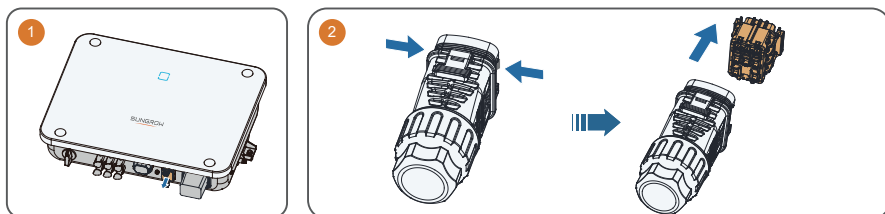

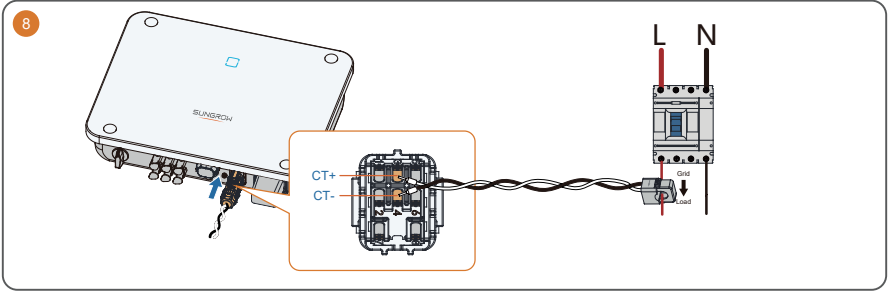
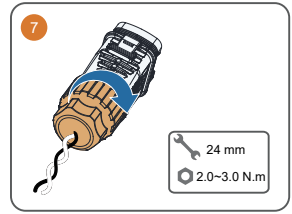
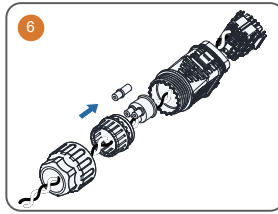
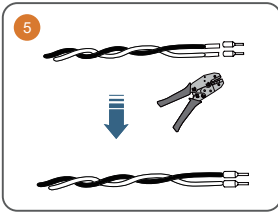
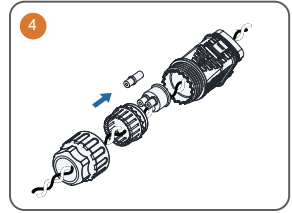
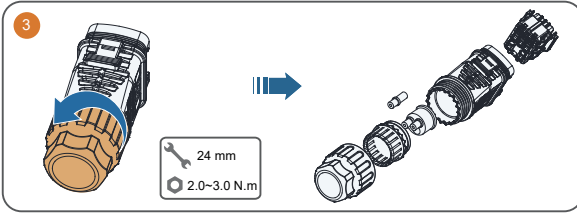



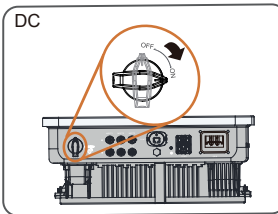
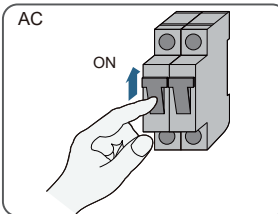

Power on / Ligar



LED panel / Painei LED

LED indicator	LED state	Definition
	ON	The inverter is normally running.
	Slow gradient flashing	The inverter is at standby or startup state (not feeding power into the grid). Manually shut down.
	Flashing	Low PV power.
	ON	A system fault has occurred(The inverter is unable to connect to the grid and feed power). A system warning is present (the inverter can still connect to the grid).
	ON	The system is being upgraded.
	OFF	Both the AC and DC sides are powered off, and the DC bus voltage has discharged (with AC auxiliary power available). The DC side are powered off, nd the DC bus voltage has discharged (AC input absent).



More information in the QR code or
at <http://support.sungrowpower.com/>

SUNGROW

Specifications are subject to changes without advance notice.

